



M5

CD/SACD Player

ENGLISH



Owner's Manual

Introduction

IMPORTANT SAFETY INSTRUCTIONS



IMPORTANT SAFETY INSTRUCTIONS

- Save these instructions for later use.
- Follow all warnings and instructions marked on the audio equipment.

1 Read instructions - All the safety and operating instructions should be read before the product is operated.

2 Retain instructions - The safety and operating instructions should be retained for future reference.

3 Heed Warnings - All warnings on the product and in the operating instructions should be adhered to.

4 Follow Instructions - All operating and use instructions should be followed.

5 Cleaning - Unplug this product from the wall outlet before cleaning. Do not use liquid cleaners or aerosol cleaners. Use a damp cloth for cleaning.

6 Attachments - Do not use attachments not recommended by the product manufacturer as they may cause hazards.

7 Water and Moisture - Do not use this product near water-for example, near a bath tub, wash bowl, kitchen sink, or laundry tub; in a wet basement; or near a swimming pool; and the like.

8 Accessories - Do not place this product on an unstable cart, stand, tripod, bracket, or table. The product may fall, causing serious injury to a child or adult, and serious damage to the product. Use only with a cart, stand, tripod, bracket, or table recommended by the manufacturer, or sold with the product. Any mounting of the product should follow the manufacturer's instructions, and should use a mounting accessory recommended by the manufacturer.

9 A product and cart combination should be moved with care. Quick stops, excessive force, and uneven surfaces may cause the product and cart combination to overturn.

10 Ventilation - Slots and openings in the cabinet are provided for ventilation and to ensure reliable operation of the product and to protect it from overheating, and these openings must not be blocked or covered. The openings should never be blocked by placing the product on a bed, sofa, rug, or other similar surface. This product should not be placed in a built-in installation such as a bookcase or rack unless proper ventilation is provided or the manufacturer's instructions have been adhered to.

11 Power Sources - This product should be operated only from the type of power source indicated on the marking label. If you are not sure of the type of power supply to your home, consult your product dealer or local power company.

- **Main Power Disconnect;** When the power switch is in the Off position, the SACD/CD-Player is not completely disconnected from the main power. The primary method of isolating the SACD/CD-Player from the mains supply is to disconnect the mains plug. Ensure that the mains plug remains accessible at all times. When installing the product, ensure that the plug is easily accessible.
- **Non-use Period;** Unplug the AC power cord from the AC outlet if the unit will not be used for a long period of time such as several months or more.
- **CLASS 1 Products;** The M5 shall be connected to a **MAINS** socket outlet with a protective earthing connection.

12 Power-Cord Protection - Power-supply cords should be routed so that they are not likely to be walked on or pinched by items placed upon or against them, paying particular attention to cords at plugs, convenience receptacles, and the point where they exit from the product.

13 Outdoor Antenna Grounding - If an outside antenna or cable system is connected to the product, be sure the antenna or cable system is grounded so as to provide some protection against voltage surges and built-up static charges. Article 810 of the National Electrical Code, ANSI/NFPA 70, provides information with regard to proper grounding of the mast and supporting structure, grounding of the lead-in wire to an antenna discharge unit, size of grounding conductors, location of antenna discharge unit, connection to grounding electrodes, and requirements for the grounding electrode.

NOTE TO CATV SYSTEM INSTALLER

- *This reminder is provided to call the CATV system installer's attention to Section 820-40 of the NEC which provides guidelines for proper grounding and, in particular, specifies that the cable ground shall be connected to the grounding system of the building, as close to the point of cable entry as practical.*

14 Lightning - For added protection for this product during a lightning storm, or when it is left unattended and unused for long periods of time, unplug it from the wall outlet and disconnect the antenna or cable system. This will prevent damage to the product due to lightning and power-line surges.

15 Power Lines - An outside antenna system should not be located in the vicinity of overhead power lines or other electric light or power circuits, or where it can fall into such power lines or circuits. When installing an outside antenna system, extreme care should be taken to keep from touching such power lines or circuits as contact with them might be fatal.

16 Overloading - Do not overload wall outlets, extension cords, or integral convenience receptacles as this can result in a risk of fire or electric shock.

17 Object and Liquid Entry - Never push objects of any kind into this product through openings as they may touch dangerous voltage points or short-out parts that could result in a fire or electric shock. Never spill liquid of any kind on the product.

WARNING

18 Transportation - Transport the M5 in the shipping containers supplied. Do not transport the M5 using one shipping container; to do so may result in damage to either the SACD/CD-player or personnel.

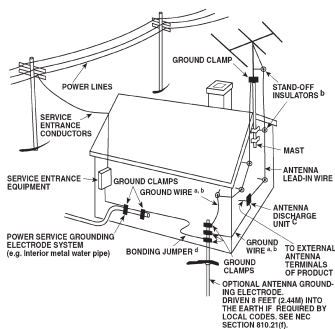

19 Damage Requiring Service - Unplug this product from the wall outlet and refer servicing to qualified service personnel under the following conditions:

- a) When the power-supply cord or plug is damaged.
- b) If liquid has been spilled, or objects have fallen into the product.
- c) If the product has been exposed to rain or water.
- d) If the product does not operate normally by following the operating instructions. Adjust only those controls that are covered by the operating instructions as an improper adjustment of other controls may result in damage and will often require extensive work by a qualified technician to restore the product to its normal operation.
- e) If the product has been dropped or damaged in any way.
- f) when the product exhibits a distinct change in performance-this indicates a need for service.

20 Replacement Parts - When replacement parts are required, be sure the service technician has used replacement parts specified by the manufacturer or have the same characteristics as the original part. Unauthorized substitutions may result in fire, electric shock, or other hazards.

21 Safety Check - Upon completion of any service or repairs to this product, ask the service technician to perform safety checks to determine that the product is in proper operating condition.

22 Wall or Ceiling Mounting - The product should be mounted to a wall or ceiling only as recommended by the manufacturer.

WARNING



TO PREVENT FIRE OR SHOCK HAZARD, DO NOT EXPOSE THIS APPLIANCE TO RAIN OR MOISTURE. THE LIGHTNING FLASH WITH ARROWHEAD SYMBOL, WITHIN AN EQUILATERAL TRIANGLE, IS INTENDED TO ALERT THE USER TO THE PRESENCE OF UNINSULATED "DANGEROUS VOLTAGE" WITHIN THE PRODUCT'S ENCLOSURE THAT MAY BE OF SUFFICIENT MAGNITUDE TO CONSTITUTE A RISK OF ELECTRIC SHOCK TO PERSONS.



THE EXCLAMATION POINT WITHIN AN EQUILATERAL TRIANGLE IS INTENDED TO ALERT THE USER TO THE PRESENCE OF IMPORTANT OPERATING AND MAINTENANCE (SERVICING) INSTRUCTIONS IN THE LITERATURE ACCOMPANYING THE APPLIANCE

CAUTION

Changes or modifications to this equipment not expressly approved by NAD Electronics for compliance could void the user's authority to operate this equipment.

CAUTION REGARDING PLACEMENT

To maintain proper ventilation, be sure to leave a space around the unit (from the largest outer dimensions including projections) equal to, or greater than, shown below.

Left and Right Panels : 10 cm

Rear Panel : 10 cm

Top Panel : 50 cm

IMPORTANT INFORMATION FOR UK CUSTOMERS

DO NOT cut off the mains plug from this equipment. If the plug fitted is not suitable for the power points in your home or the cable is too short to reach a power point, then obtain an appropriate safety approved extension lead or consult your dealer. If, nonetheless, the mains plug is cut off, REMOVE THE FUSE and dispose of the PLUG immediately, to avoid possible shock hazard by inadvertent connection to the mains supply. If this product is not provided with a mains plug, or one has to be fitted, then follow the instructions given below:

IMPORTANT

DO NOT make any connection to the larger terminal which is marked with the letter 'E' or by the safety earth symbol or coloured GREEN or GREEN AND YELLOW.

The wires in the mains lead on this product are coloured in accordance with the following code:

BLUE - NEUTRAL

BROWN - LIVE

As these colours may not correspond with the coloured markings identifying the terminals in your plug, proceed as follows:

The BLUE wire must be connected to the terminal marked with the letter 'N' or coloured BLACK.

The BROWN wire must be connected to the terminal marked with the letter 'L' or coloured RED

When replacing the fuse, only a correctly rated and approved type should be used, and be sure to re-fit the fuse cover.

IF IN DOUBT CONSULT A COMPETENT ELECTRICIAN

This product is manufactured to comply with the radio interference requirements of EEC DIRECTIVE 89/336/EEC, 93/68/EEC, and 73/23/EEC.

NOTES ON ENVIRONMENTAL PROTECTION

At the end of its useful life, this product must not be disposed of with regular household waste but must be returned to a collection point for the recycling of electrical and electronic equipment. The symbol on the product, user's manual and packaging, point this out. The materials can be reused in accordance with their markings. Through re-use, recycling of raw materials, or other forms of recycling of old products, you are making an important contribution to the protection of our environment. Your local administrative office can advise you of the responsible waste disposal point.



Introduction

IMPORTANT SAFETY INSTRUCTIONS

CLASS 1 LASER PRODUCT
KLASSE 1 LASER PRODUKT
LUOKAN 1 LASER LAITE
KLASS 1 LASER APPARAT
CLASSE 1 PRODUIT LASER

WARNING: TO REDUCE THE RISK OF FIRE OR ELECTRIC SHOCK, DO NOT EXPOSE THIS PRODUCT TO RAIN OR MOISTURE

CAUTION

THIS CD/SACD player EMPLOYS A LASER SYSTEM. TO ENSURE PROPER USE OF THIS PRODUCT, PLEASE READ THIS OWNER'S MANUAL CAREFULLY AND RETAIN FOR FUTURE REFERENCE. SHOULD THE UNIT REQUIRE MAINTENANCE, CONTACT AN AUTHORIZED SERVICE LOCATION.

USE OF CONTROLS, ADJUSTMENTS TO MODIFY PERFORMANCE OF PROCEDURES OTHER THAN THOSE SPECIFIED MAY RESULT IN HAZARDOUS RADIATION EXPOSURE.

TO PREVENT DIRECT EXPOSURE TO LASER BEAM, DO NOT TRY TO OPEN THE ENCLOSURE. VISIBLE LASER RADIATION EXISTS WHEN THE ENCLOSURE IS OPENED. DO NOT STARE INTO BEAM.

THE APPARATUS SHALL NOT BE EXPOSED TO DRIPPING OR SPLASHING AND THAT NO OBJECTS FILLED WITH LIQUIDS, SUCH AS VASES, SHALL BE PLACED ON THE APPARATUS.

WARNING: CHANGES OR MODIFICATIONS NOT EXPRESSLY APPROVED BY THE PARTY RESPONSIBLE FOR COMPLIANCE COULD VOID THE USER'S AUTHORITY TO OPERATE THE EQUIPMENT.

NOTE

M5 is not an auto voltage CD/SACD player. Connect only to the prescribed AC outlet, i.e., 120V 60Hz or 230V 50Hz.

RECORD YOUR MODEL NUMBER (NOW, WHILE YOU CAN SEE IT) The model and serial number of your new CD/SACD player are located on the back of the CD/SACD player cabinet. For your future convenience, we suggest that you record these numbers here:

Model No. : _____ Serial No. : _____

NAD is a trademark of NAD Electronics International, a division of Lenbrook Industries Limited
Copyright 2006, NAD Electronics International, a division of Lenbrook Industries Limited

TABLE OF CONTENTS

INTRODUCTION	
Important Safety Instructions	2-4
IDENTIFICATION OF CONTROLS	
Front Panel/Display window	5
Rear Panels	6
Preparing The Remote Control	7
Remote Control	8
Operation Of The M5 With The Remote Control	9
OPERATION	
Operation of the M5	10
Introduction	10
Special Playback	11-12
Automatic Power Off Function	11
Skipping Tracks and Indexes	11
Scanning at High Speed (SACD/CD)	11
Repeat	11
Repeating sections between two specific points (A-B REPEAT)	12
Random Playback	12
Program Mode	12
Playback with CD, SACD, MP3 and WMA	13
Connecting to a Multi-channel Sound System (SACD)	13
SPECIAL FEATURES	
Default Settings	14-15
General OSD Navigation	14
Audio	14
Video	15
Language	15
System Restore	15
REFERENCE	
Troubleshooting	16
Specifications	17

Identification of Controls

FRONT PANEL

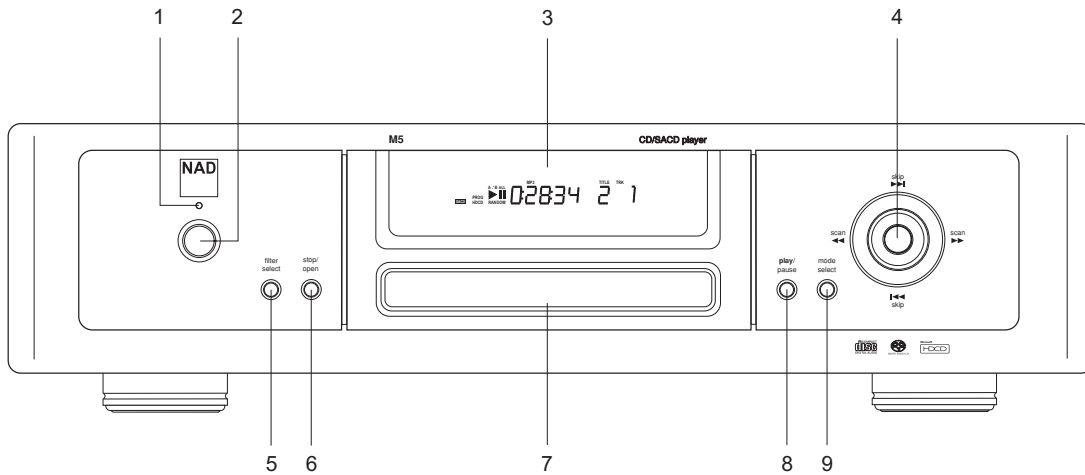

- 1-2 Power button and On/Standby indicator
- 3 Display window
- 4 Select/Enter/Navigation buttons
- 5 **filter select** button (select between Normal bandwidth or Slow bandwidth) for CD, MP3 and WMA media.
- 6 **stop/open** button
- 7 CD tray
- 8 **play/pause** button
- 9 **mode select** button (select between SACD or CD)

DISPLAY WINDOW

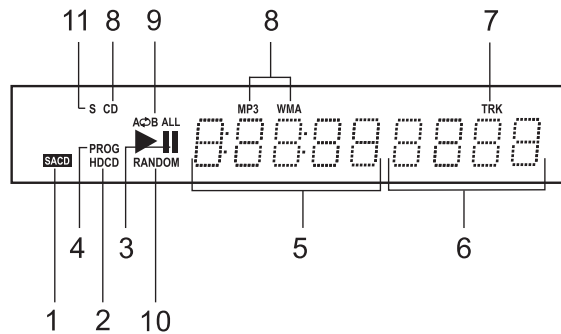

- 1 **SACD** multi-channel output indicator
- 2 **HDCC** indicator
- 3 Play and Pause indicators
- 4 **PROG**ram indicator
- 5 Total playing time display and text readout
- 6 Track number display indicator and text readout
- 7 **TRK** indicator
- 8 **CD/MP3/WMA** indicators
- 9 Repeat, repeat **ALL**, repeat **A-B** indicator
- 10 **RANDOM** play indicator
- 11 **Slow Filter** indicator

Identification of Controls

REAR PANEL

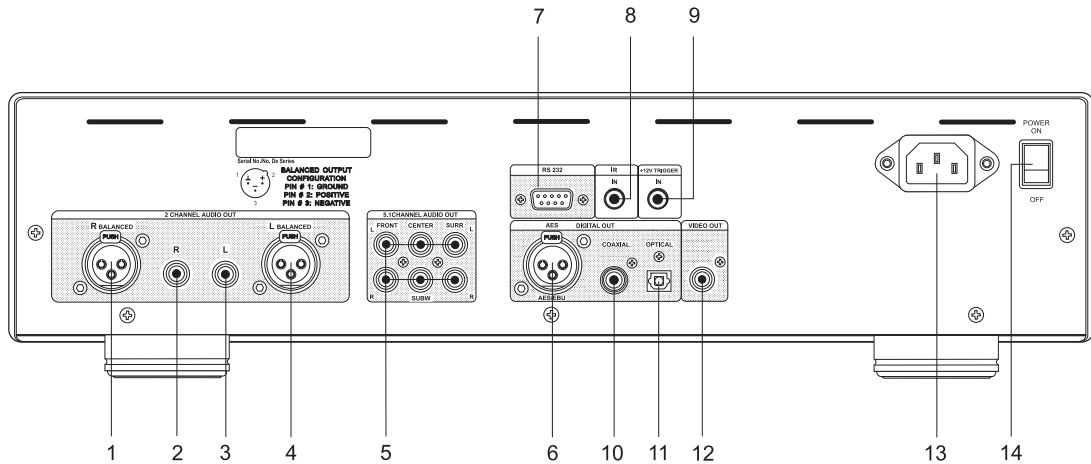

- 1 Analog Right Balanced OUT Jack.
- 2 Analog Audio Right OUT Jack.
- 3 Analog Audio Left OUT Jack .
- 4 Analog Left Balanced OUT Jack.
- 5 SACD Multi-channel Audio Output:
 - 5.1 CH AUDIO OUT FRONT L & R Jacks
 - 5.1 CH AUDIO OUT CENTER and SUBW (Subwoofer) Jacks
 - 5.1 CH AUDIO OUT SURR (Surround Sound) L & R Jacks
- 6 Digital OUT Balanced AES/EBU Jack.
- 7 RS 232 In/Out Jack.
- 8 IR IN Jack.
- 9 +12V Trigger IN Jack.
- 10 Coaxial OUT Jack
- 11 Optical OUT Jack
- 12 Composite Video OUT Jack (NTSC, PAL, PAL 60)
- 13 Power cord socket (120V North American, 230V European)
- 14 POWER ON/OFF

NOTES

Connect the optical digital cable (not supplied) firmly so that the configurations of both the cable and the connector match.

The **+12V TRIGGER IN** jack is a 3.5mm monotype miniature phone jack with the centre pin the +12V signal-sense. We recommend that you use a good quality cable with shield when attaching the 3.5mm monotype plug so as to prevent false triggering of the SACD/CD-player due to electro-magnetic interference from nearby electronic equipment. The **+12V-IN TRIGGER** allows you to have an external +12V signal to turn ON the NAD M5 from standby. This +12V signal must be a continuous +12V signal in order to keep the M5 in the ON state. Once you remove the +12V signal the M5 will return to standby. Check the specifications of the trigger input terminal the other components to ensure these are compatible with the M5. All **+12V-TRIGGER** inputs and outputs on other NAD components with a **+12V-TRIGGER** feature are fully compatible with the NAD M5's **+12V-TRIGGER IN**. Before making any connections to any **+12V-TRIGGER IN** make sure all components are disconnected from the AC mains. If in doubt over the connections, installation and/or operation of the **+12V-TRIGGER IN** connection, consult your NAD dealer or sales representative. Failure to observe the above may result in damage to the NAD M5 and/or any ancillary components attached to it.

The **IR IN** jack is connected to the output of an IR (infrared) repeater (Xantech or similar), or the IR output of another component to allow control of the M5 from a remote location. Ask your dealer or custom installer for further details

The **AES/EBU DIGITAL OUTPUT** is a professional standard digital output. The signal is available from the XLR/Cannon connector marked AES/EBU, permitting the ultimate in high quality digital transmission with the best associated equipment. The serial data output is taken after error correction but before digital-to-analog conversion and filtering. The output is transformer-isolated from the built-in D-to-A circuits.

The **BALANCED** Right and Left Outputs connects to an integrated amplifier or preamplifier that uses balanced XLR input connectors, such as the NAD M3. The wiring standard used for these connectors is; Pin 1 Chassis Earth (GROUND), Pin 2 Hot (+ OUT), and Pin 3 Signal Ground (- OUT)

The **RS-232** connector is a standard DB-9 RS-232 configuration. Use an "off-the-shelf" DB-9 RS-232 serial cable to connect between your Windows® PC's DB-9 RS-232 connector and the M5's **RS-232** connector.

For multi-channel SACD surround sound, connect the **5.1 CHANNEL AUDIO OUT** for 2-channel and multi-channel SACD media to your 5.1 surround sound preamplifier.

For CD, MP3, and WMA PCM media connect the **2 CHANNEL AUDIO OUT** to your stereo system. PCM media is only available on both **Analog Audio OUT** and **DIGITAL OUT**.

Identification of Controls

PREPARING THE REMOTE CONTROL

Insert the batteries into the remote control so you can use it to operate the M5.

- 1 Open the battery cover
- 2 Insert two batteries (AA size)
- 3 Make sure to match the + and - on the batteries to the marks inside the battery compartment.
- 4 Close the cover

NOTES ON BATTERIES

Improper use of batteries may cause battery leakage and corrosion.

- To operate the remote control correctly, follow the instructions.
- Do not insert the batteries into the remote control in the wrong direction.
- Do not charge, heat, open or short-circuit the batteries.
- Do not throw the batteries into fire.
- Do not leave dead or exhausted batteries in the remote control.
- Do not use different types of batteries together, or mix old and new batteries.
- If you do not use the remote control for a long period of time, remove the batteries to avoid possible damage from battery corrosion.
- If the remote control does not function correctly or if the operating range becomes reduced, replace all batteries with new ones.
- If battery leakage occurs, wipe the battery liquid from the battery compartment, then insert new batteries.
- The batteries should last about one year with normal use.

OPERATION OF THE M5 WITH THE REMOTE CONTROL

Point the remote control at the remote control sensor and press the buttons.

Distance: About 23 ft (7 m) from the front of the remote sensor

Angle: About 30 degrees in each direction of the front of the remote sensor

NOTES ON THE REMOTE CONTROL

- Do not expose the remote sensor of the M5 to a strong light source such as direct sunlight or illumination. If you do so, you may not be able to operate the M5 with the remote control.
- Point the remote control at the remote sensor on the M5.
- Do not drop or give the remote control a shock.
- Do not leave the remote control near an extremely hot or humid place.
- Do not spill water or put anything wet on the remote control.
- Do not disassemble the remote control.

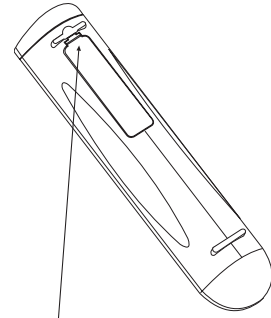

PRESS IN AND LIFT TAB TO REMOVE BATTERY COVER OUT FROM RECESS

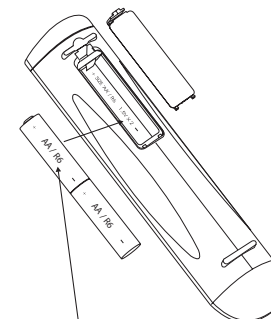

PLACE BATTERIES INTO OPENING. ENSURE THE CORRECT POLARITY IS OBSERVED

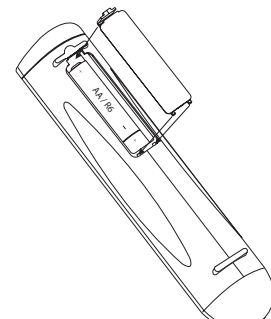

PRESS BATTERY COVER INTO PLACE UNTIL IT 'CLICKS' CLOSED

Identification of Controls

REMOTE CONTROL

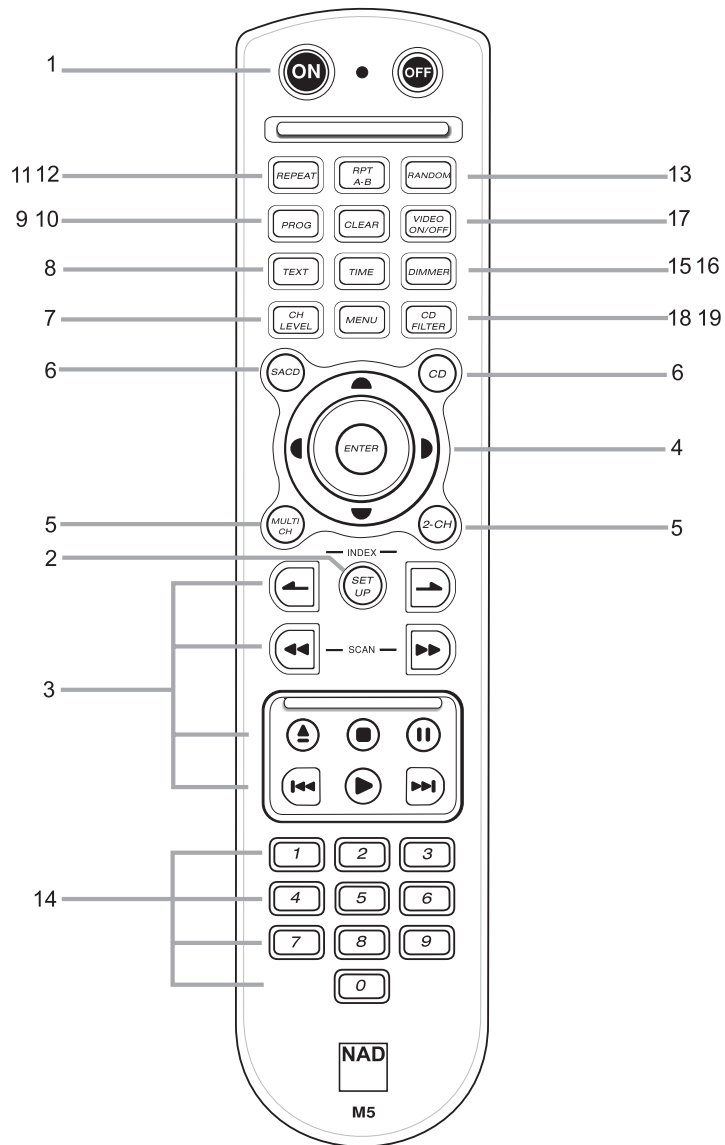

1 POWER ON, POWER OFF

2 SETUP

3 Transport control buttons: OPEN/CLOSE, STOP, PAUSE, STEP, PLAY, SKIP, SCAN, SACD INDEX

4 ENTER and navigation buttons

5 SACD MULTI-CH and SACD 2-CH buttons

6 SACD and CD buttons

7 CH LEVEL (Channel Level)

8 TEXT

9 PROGRAM

10 CLEAR

11 REPEAT

12 REPEAT A-B

13 RANDOM

14 Numerical buttons

15 VFD DIMMER

16 TIME

17 VIDEO ON/OFF

18 CD FILTER

19 MENU

- 1 The power buttons labelled **ON** and **OFF** will toggle the M5 from standby to the on-position, only if the **POWER** rocker switch on the left rear of the M5 is in the **ON** position.
- 2 The **SETUP** button for editing the M5's output settings.
- 3 There are ten transport control buttons that allows one to directly control the CD/SACD media. These buttons handle the basic operations of; Open/Close ▲ of the media tray, Stop ■, Pause ||, Skip forward and back ◀▶, Play ▶, Scan tracks ◀▶, and Index tracks ↔.
- 4 The navigation buttons ◀▶/▶/◀ in conjunction with the **ENTER** button allows one to navigate the OSD, title and menu screens.
- 5 Direct multi-channel and 2-channel selection of Hybrid SACD selection. Select 2-channel or multi-channel audio output from the audio analog jacks.
- 6 For Hybrid SACD media, select **CD** stereo 2-channel or **SACD** multi-channel audio.
- 7 For SACD multi-channel media. Press **CH LEVEL** and then using the navigation buttons fine adjust the level of the selected channel. Press the left/right navigation buttons to select the desired channel. Press the **CH LEVEL** to exit the adjustments.
- 8 For SACD multi-channel media. Press **TEXT** to display the recorded documentation of the artist and the music title being played. This information will be scrolled across the VFD.
- 9 In Stop mode, use the **PROGRAM** button to select the order in which the media will be played. You may program a maximum of 20 songs.
- 10 In Stop mode, use the **CLEAR** button to edit the programmed selection.
- 11 Select **REPEAT** to repeat a single track or repeat the entire disc. To clear the **REPEAT** function toggle the **REPEAT** button until the **REPEAT** icon is cleared from the VFD.
- 12 Select **REPEAT A-B** if you want to repeat only a section of a song being played. Press once for the start point and a second time for the end point. Press a third time to clear the **REPEAT A-B** function.
- 13 Select the **RANDOM** function to randomly play various tracks on the CD or SACD player. Press once to engage the **RANDOM** function, a second time to clear the **RANDOM** function.
- 14 The number buttons are used for inputting numeric values when directly selecting media tracks.
- 15 Select the **DIMMER** function for dimming the M5's VFD. There are three levels; low, medium, and high brightness. The default is high brightness.
- 16 In Play mode, use the **TIME** button to display either; total time remaining or total time elapsed on the entire disc, as well as time remaining or elapsed per track on the VFD.
- 17 The **VIDEO ON/OFF** button is used to switch on and off the video output signal.
- 18 The **CD FILTER** button is used for selecting the bandwidth of the audio low pass filter for the CD media being played. The options are **NORMAL** Bandwidth and **SLOW** Bandwidth. For some recordings the **SLOW** Bandwidth may provide a wide frequency range and spatial feeling. Toggle between these two settings when the media is in **STOP** mode. This feature is not available for SACD media.
- 19 The **MENU** button automatically stops play of any media and returns the M5 to the primary menu of the media being played. For MP3 and WMA recordings the menu will become the recorded root directory. For Hybrid SACDs, the menu becomes the CD/SACD selection directory.

INTRODUCTION

When you want to play back SACD, MP3, WMA or audio CDs, turn on your audio system and the TV and then select the Composite Video input source connected to the CD/SACD player.

Switch ON the rear panel POWER rocker switch. The M5-power indicator becomes blue.

Press OPEN/CLOSE. The disc tray opens.

- You can open the disc tray by pressing this button even if the CD/SACD player is in standby mode. The power indicator will turn from amber to blue.

Place a disc on the disc tray with the playback side down.

- There are two different disc sizes. Place the disc in the correct guide on the disc tray. If the disc is out of the guide, it may damage the disc and cause the M5 to malfunction. Press **PLAY**. The disc tray is automatically closed and playback begins.
- If the disc is placed in upside down (and it is a single sided disc), NO DISC will appear on the M5's VFD display.
- If you insert an audio SACD/CD, the total tracks and time will appear.
- After playing back all of the tracks, the M5 automatically stops and returns to the menu screen.

Press the navigation keys then and press ENTER, or press the numeric button(s), to select the desired item. Play of the selected item now begins.

- For further information, also refer to the jacket or case of the disc you are playing.

AFTER OPERATION

When the unit is not in use, remove the disc and press the **OFF** button on the remote to switch the M5 to standby. If the M5 is left unattended for any length of time such as during a vacation, then switch off the M5 by depressing the black rocker switch marked **POWER ON/OFF** found on the rear of the M5.

NOTES

- Do not move the CD/SACD player during playback. Doing so may damage the disc and the M5.
- Use the **OPEN/CLOSE** button on the M5 or  on the remote control to open and close the disc tray.
- Do not push or pull the disc tray while it is moving. Doing so may cause the M5 to malfunction.
- Do not push up the disc tray or put any objects other than discs on the disc tray. Doing so may cause the M5 to malfunction.
- Keep your fingers well clear of the disc tray as it is closing. Be especially careful with children's fingers around the closing disc tray, as there is a risk of personal injury.
- Depending on the SACD media, some operations may be different or restricted. Refer to the jacket or case of the disc you are playing.

AUTOMATIC POWER OFF FUNCTION

The M5 can be powered to standby by the **12V-TRIGGER IN**. Also, the M5 will automatically turn itself to standby mode after the Screen Saver has been engaged for about 8 minutes.

STOPPING PLAY

Press STOP during playback either on the remote or the M5.

SKIPPING TRACKS AND INDEXES**SKIPPING FORWARD**

Press ►► or → during playback. A track or index is skipped each time the button is pressed.

SKIPPING BACK

Press ◀◀ or ← during playback. When the button is pressed once midway through a track or index, the player returns to the start of that track or index. When ◀◀ or ← is pressed again, track or index is skipped each time the button is pressed.

SCANNING AT HIGH SPEED (CD, SACD)

You can play back discs at various speeds. To scan at fast-forward or fast-reverse during playback, press the Scan buttons ◀◀, or ►► during playback

The speed of advance (reverse) is relatively slow at first. When the button is pressed again, the speed becomes faster. (Each time the button is pressed, the speed increases up to 5 steps for CD). The speed will be retained even after the button is released. To return to normal playback, press **PLAY**

NOTES

- *The CD/SACD player does not play back sound during the high-speed reverse and forward playback.*
- *Not all media support maximum speeds for scanning.*

REPEAT

Press REPEAT during playback. Each time this button is pressed, the TV screen changes as shown below and the disc will repeat a track.

SACD/CD/MP3/WMA

Repeat of track being played.

Repeat of disc being played.

Cancel repeat mode (normal play).

TO PROGRAM REPEAT PLAY (CD/SACD)

If REPEAT is pressed during program play, repeat play is operated as below.

Repeat of the current programmed track

Repeat of all programs

Cancel repeat mode by pressing the REPEAT button several times until REPEAT OFF is displayed

REPEATING SECTIONS BETWEEN TWO SPECIFIC POINTS (A-B REPEAT)

- 1 Press A-B during play at the point where repeat play is to start (A).
- 2 Press A-B during play at the point where repeat play is to be concluded (B). Repeat play of the selection between points A and B starts.

To return to normal play

Press A-B button once, 'REPEAT OFF' is displayed.

NOTES

- Repeat play works only with discs for which the elapsed playing time appears in the display window during playback.
- Repeat play may not work correctly with some SACDs.
- A-B repeat play works only within a track of the media.
- Repeat and Play may not work with MP-3 encoded CD-R and CD-RW.

RANDOM PLAYBACK

- 1 Press RANDOM during normal playback or stop mode. The M5 automatically starts random playback and the RANDOM indicator will appear in the M5's display.

- 2 To resume normal playback, press RANDOM.

NOTE

- You can playback tracks in random order. (Random playback)
- Random playback may not be possible on certain discs.
- If you press the SKIP button during random playback, the CD/SACD player goes to another track randomly and starts playback.

PROGRAM MODE

The player plays the tracks on the disc in the order you specify.

- 1 Press PROGRAM during stop mode. The program playback screen appears on the TV screen. To exit the screen, press PLAY or PROGRAM.

- 2 Press the numeric button(s) to select the desired track number. Press ENTER to store the track. Repeat step 2 to select another track. Up to 20 tracks can be programmed.

- 3 Press PROGRAM or PLAY to exit the screen. The selected track is stored in the memory and play now begins in the programmed sequence.

If you press PROGRAM to exit the screen, the selected tracks are memorized. If you press PROGRAM after clearing 'Resume Play' the selected programmed tracks are cleared.

NOTE

After playback of all programmed tracks, play is stopped.

CLEARING THE PROGRAM

To clear the programmed tracks one by one

Press navigation buttons to select the unwanted number and then press CLEAR on the M5 remote.

Press PROGRAM to exit the screen (The programs are also cleared when the power is turned off or the disc removed.)

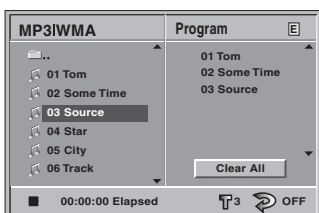
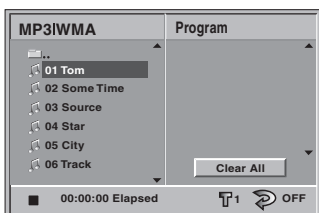
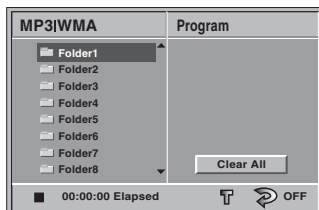

PLAYBACK AUDIO WITH CD, SACD, MP3 AND WMA

CD/SACD

Press CD or SACD on the M5 remote, during play.

MP3/WMA

Press MENU until the desired media directory is selected, and then press ENTER.

CONNECTING TO A MULTI-CHANNEL SOUND SYSTEM (SACD)

Connect the audio outputs to your integrated multi-channel amplifier or multi-channel preamplifier as shown below. Then set up the speaker bass response and configuration as per the 5.1 SPEAKER SETUP, or while playback of the multi-channel SACD media.

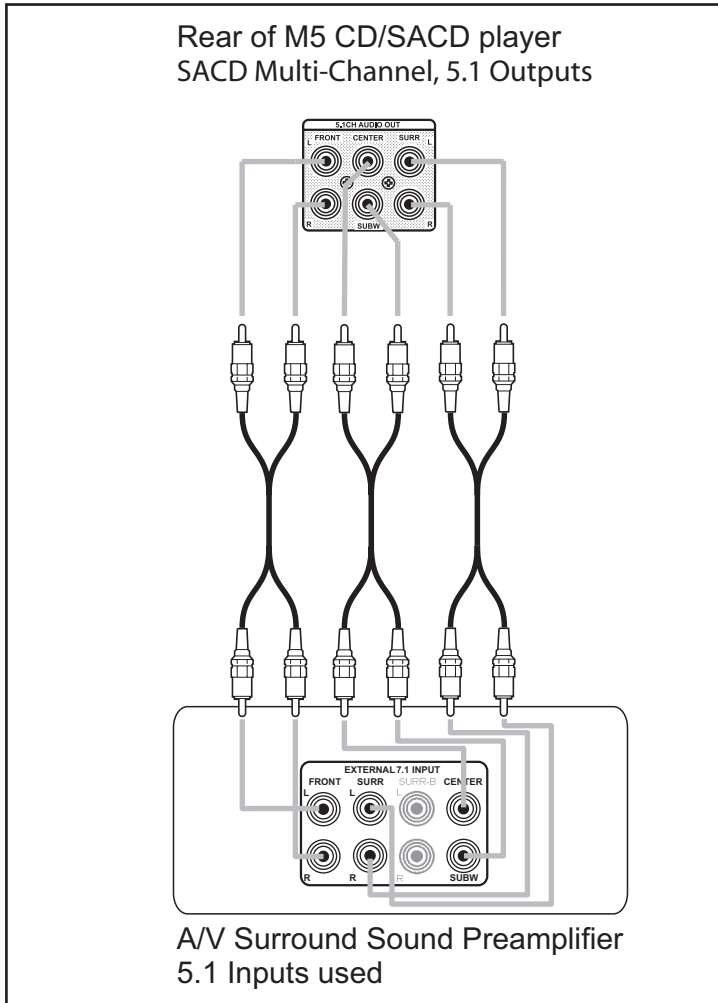

NOTES:

- For multi-channel SACD surround sound, connect the **5.1 CHANNEL AUDIO OUT** for 2-channel and multi-channel SACD media to your 5.1 surround sound preamplifier.
- For CD, MP3, and WMA PCM media connect the **2 CHANNEL AUDIO OUT** to your stereo system. PCM media is only available on both **Analog Audio OUT** and **DIGITAL OUT**.

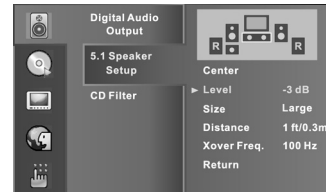

Special Features

DEFAULT SETTINGS

- Audio
- CD/SACD
- Video
- Language
- System Restore

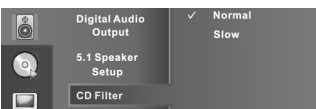
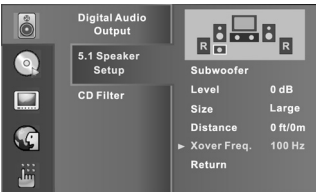
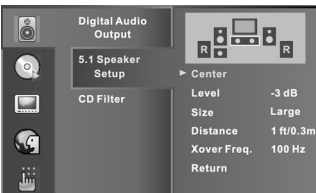
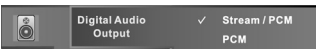

By using the Setup menu, you can make various adjustments to items such as channel levels, speaker size, and crossover frequency. You can also set a language of OSD and SACD text. These settings will be retained in the memory until they are changed, even if the power is switched off.

GENERAL OSD NAVIGATION

- 1 Press **SETUP**. The Setup menu appears.
- 2 Use **▲/▼** to select the desired option then press **▶** to move to the second level. The screen shows the current setting for the selected item, as well as alternate setting(s).
- 3 Use **▲/▼** to select the second desired option then press **▶** to move to the third level.
- 4 Use **▲/▼** to select the desired setting then press **ENTER** to confirm your selection. Some items require additional steps.
- 5 Press **SETUP** to exit the Setup menu.

AUDIO

DIGITAL AUDIO OUT

Stream/PCM: Select this option if you connect the CD Player's **DIGITAL OUT** jacks to a surround sound processor or other equipment with a Dolby Digital, DTS, or MPEG decoder.

PCM: Select when connected to a two-channel digital stereo preamplifier. CDs encoded in Dolby Digital or MPEG will be automatically downmixed to two-channel PCM audio.

5.1 SPEAKER SETUP

Speaker selection: Using the **◀/▶** arrows select each speaker you want to adjust and then navigate **▲/▼** to the options to change.

Level: Using the **◀/▶** arrows, increase or decrease the level of the channel from -10 dB to 0 dB. The default is 0 dB.

Size: Using the **◀/▶** arrows, select the best size representation of your speakers. The high-pass frequency of the Small speakers will be at the crossover frequency set in the Subwoofer menu. The channel will be full frequency response when speakers are set to Large.

Distance: Using the **◀/▶** arrows, select the distance of the front and rear speakers relative to the listening position. The Center distance is then set relative to the front speaker's settings.

Xover Freq.: Using the **◀/▶** arrows to adjust the crossover frequency for both Subwoofer and Small Speakers.

Return: First select Return and then press **ENTER** on the remote to save your settings once completed.

CD FILTER

Normal: Select Normal bandwidth to engage the a standard CD high-pass filter slope for playback of CD music through the two channel stereo audio jacks.

Slow: Select Slow bandwidth to engage a gentle high-pass filter slope for playback of CD music through the two channel stereo audio jacks. This feature is particularly useful for higher bit rate recordings.

SACD/CD

AUTOPLAY:

OFF: Select OFF when you want to press the play button on the remote or front panel to start the playback sequence. Press **ENTER** to save the setting.

ON: Select ON when you want the M5 to start playing media when turned on or the disc tray is closed. Press **ENTER** on the remote control to save the setting.

SACD/CD LAYER:

SACD: Select SACD when you want the M5 to automatically play the SACD layer of SACD/CD media. Press **ENTER** on the remote control to save the setting.

CD: Select CD when you want the M5 to automatically play the CD layer of SACD/CD media. Press **ENTER** to save the setting.

SACD MODE:

2-Channel: Select 2-Channel when you want the M5 to automatically play 2-channel SACD audio at startup. Press **ENTER** on the remote control to save the setting.

Multi-Channel: Select Multi-Channel when you want the M5 to automatically play all 5.1 SACD audio at startup. Press **ENTER** on the remote control to save the setting.

VIDEO

SIGNAL MODE

There are three settings to choose from; NTSC, PAL, and PAL-60. Select one that best matches your TV and then press **ENTER** on the remote control to save the setting.

BLACK LEVEL

Personal taste may require the adjustment of the black level for the video you are viewing to either "0" or "+7.5" IRE. This adjustment sets the reference level for absolute black as seen on your TV set. Press **ENTER** on the remote control to save the setting.

NOTES

- The black level defaults are different for each type of M5; NTSC M5 is +7.5 IRE, PAL M5 is 0 IRE.
- Setting the black level incorrectly may result in poor contrast.

VIDEO OUTPUT

ON: Select ON when you want the M5 to automatically output video on the COMPOSITE OUT RCA jack at startup. Press **ENTER** on the remote control to save the setting.

OFF: Select OFF when you want the M5 to turn off the output video on the COMPOSITE OUT RCA jack at startup. Press **ENTER** on the remote control to save the setting.

LANGUAGE

OSD

Select between the eight languages for the M5's default OSD. Press **ENTER** on the remote control to save the setting.

DISC TEXT (SACD)

If the SACD media supports multiple languages, then the disc text can be scrolled across the VFD as in the language of choice. Press **ENTER** on the remote control to save the setting.

SYSTEM RESTORE

RESTORE SETTINGS

Yes: Select Yes and then press **ENTER** on the remote control.

No: Select No and then press **ENTER** on the remote control to back out of the Restore Settings menu.

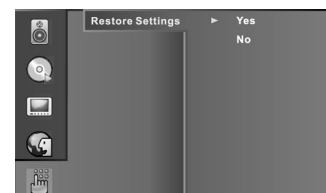
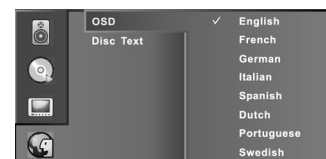
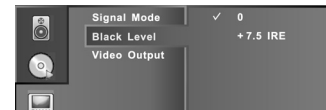
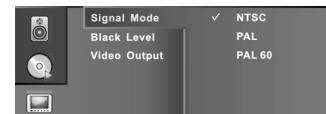
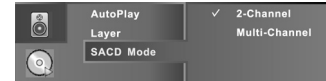
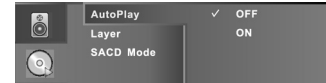

Reference

TROUBLESHOOTING

SYMPTOMS AND CORRECTION

Check the following guide for the possible cause of a problem before contacting service.

SYMPTOM	CAUSE	CORRECTION
No power	<ul style="list-style-type: none"> The power cord is disconnected 	<ul style="list-style-type: none"> Plug the power cord into the wall outlet securely.
The power is on, but the CD/SACD player does not work	<ul style="list-style-type: none"> No disc is inserted. 	<ul style="list-style-type: none"> Insert a disc (Check that the MP3, WMA, CD or SACD indicator in the M5's display is lit).
No picture	<ul style="list-style-type: none"> The TV is not set to receive signal output. 	<ul style="list-style-type: none"> Select the appropriate video input mode on the TV so that the picture from the CD/SACD player appears on the TV screen.
	<ul style="list-style-type: none"> The Video is turned off. 	<ul style="list-style-type: none"> Turn on the video via M5 remote
	<ul style="list-style-type: none"> The video cable is not connected securely. 	<ul style="list-style-type: none"> Connect the video cable into the jacks securely.
	<ul style="list-style-type: none"> The connected TV power is turned off. 	<ul style="list-style-type: none"> Turn on the TV.
No sound	<ul style="list-style-type: none"> The equipment connected with the audio cable is not set to receive CD/SACD signal output. 	<ul style="list-style-type: none"> Select the correct input mode of the audio receiver so you can listen to the sound from the CD/SACD player.
	<ul style="list-style-type: none"> The audio cables are not connected securely. 	<ul style="list-style-type: none"> Connect the audio cable into the jacks securely.
	<ul style="list-style-type: none"> The power of the equipment connected with the audio cable is turned off. 	<ul style="list-style-type: none"> Turn on the equipment connected with the audio cable.
	<ul style="list-style-type: none"> The Audio output settings are incorrect. 	<ul style="list-style-type: none"> Select the digital and analog output settings depending on your hardware configuration.
	<ul style="list-style-type: none"> The media is PCM only and the Analog Audio Output is not connected 	<ul style="list-style-type: none"> Connect Analog Audio Output to your preamplifier for playback of PCM music.
The CD/SACD player does not start playback	<ul style="list-style-type: none"> No disc is inserted. 	<ul style="list-style-type: none"> Insert a disc (Check that the indicator in the M5's display is lit, SACD, CD, MP3, WMA).
	<ul style="list-style-type: none"> An unplayable disc is inserted. 	<ul style="list-style-type: none"> Insert a playable disc.
	<ul style="list-style-type: none"> The disc is placed upside down. 	<ul style="list-style-type: none"> Place the disc with the playback side down.
	<ul style="list-style-type: none"> The disc is not placed within the guide. 	<ul style="list-style-type: none"> Place the disc on the disc tray correctly inside the guide.
	<ul style="list-style-type: none"> The disc is dirty. 	<ul style="list-style-type: none"> Clean the disc.
	<ul style="list-style-type: none"> A menu is on the TV screen. 	<ul style="list-style-type: none"> Press the SETUP button to turn off the menu screen.
	The remote control does not work properly	<ul style="list-style-type: none"> The remote control is not pointed at the remote sensor of the CD/SACD player.
<ul style="list-style-type: none"> The remote control is too far from the CD/SACD player. 		<ul style="list-style-type: none"> Operate the remote control within about 23 ft (7 m).
<ul style="list-style-type: none"> There is an obstacle in the path of the remote control and the CD/SACD player. 		<ul style="list-style-type: none"> Remove the obstacle.
<ul style="list-style-type: none"> The batteries in the remote control are exhausted. 		<ul style="list-style-type: none"> Replace the batteries with new ones.

Audio DAC	192 KHz/24 Bit
MP3 Decoder	Digital Output, Stereo on downmix output
WMA Decoder	Digital Output Stereo on downmix output
SACD	5.1 Channel support on analogue outputs 2.0 Channel support on analogue outputs 2.0 Channel XLR balanced analogue outputs
Digital Audio Output	Coaxial Output Optical Output AES/EBU Balanced digital Output
Video output	Composite Video (480i/576i)
TV Type Setup	PAL/PAL-60/ NTSC
Operating temperature	5 °C to 35 °C (41 °F to 95 °F)
Operating humidity	5 % to 90 %
Shipping Weight Net	8.63 kg (19 lb)
Shipping Weight Gross	15.2 kg (33.5 lb)
Unit Dimensions (W x H x D)*	Net 435 mm x 100 mm x 300 mm Gross 435 mm x 114 mm x 305 mm

*Gross dimensions include feet, disc tray, and rear connections

Specifications are subject to change without notice. For updated documentation and features please log onto

www.nadelectronics.com for the latest information about your M5.



www.NADelectronics.com

**©2006 NAD ELECTRONICS INTERNATIONAL
A DIVISION OF LENBROOK INDUSTRIES LIMITED**

All rights reserved. No part of this publication may be reproduced, stored or transmitted in any form without the written permission of NAD Electronics International

M5 Manual 07/06